

Top view

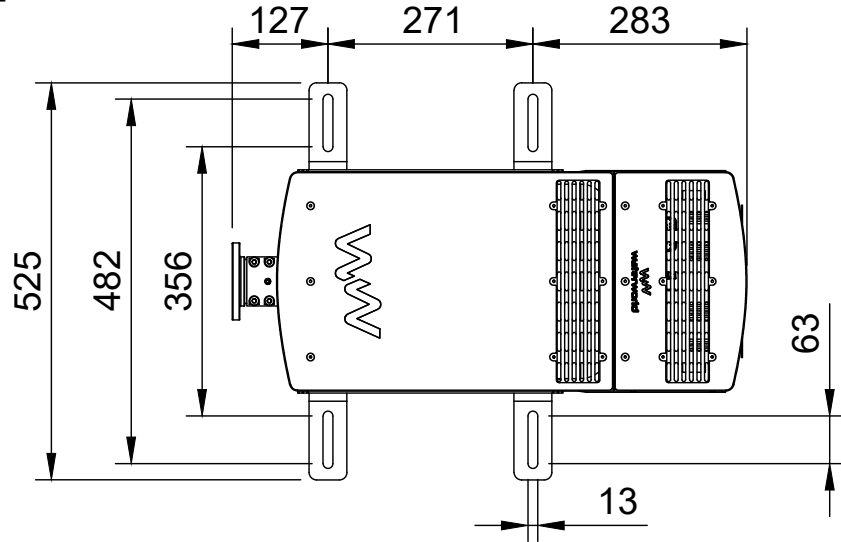

Isometric view

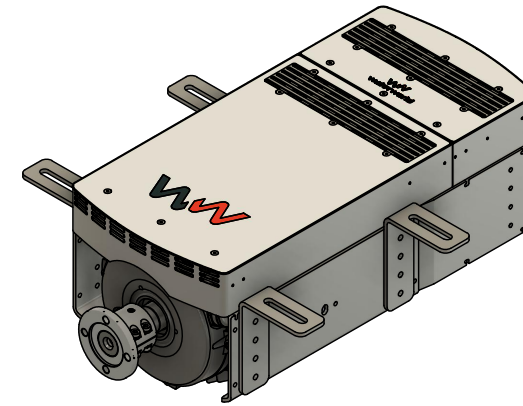

Side view

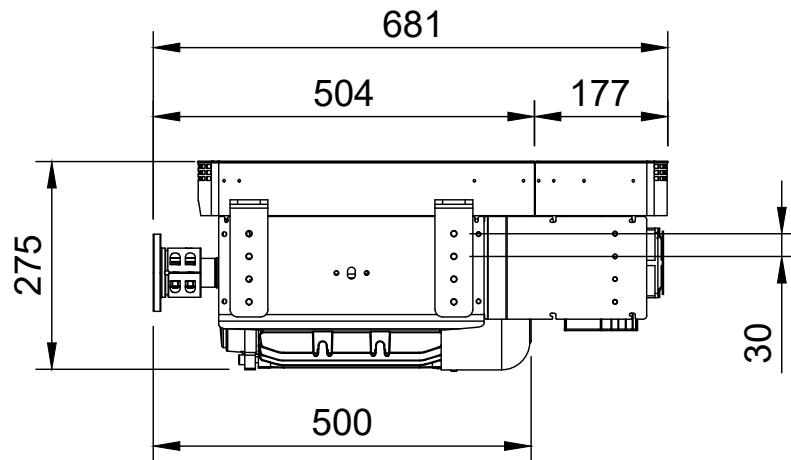

Front view

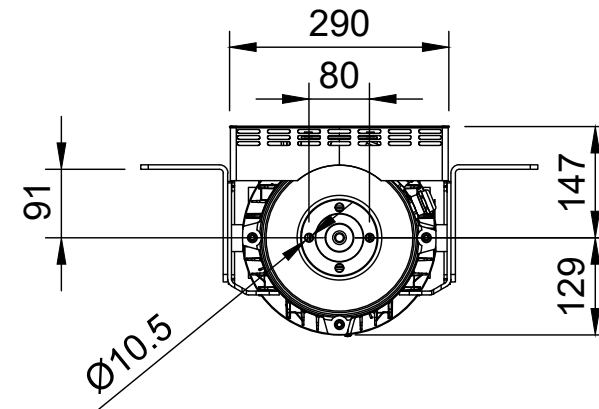

Title		Article No.		
10 kW Inboard motor		WW-12xx100A		
Created by		Drawing scale	Units	Paper size
S.R. Roorda		1:10	mm	A4
Document type		Rev.	Date of issue	Sheet
Dimension drawing		1	8-3-2024	1/1